

ACH480 drives

Quick installation and start-up guide



Safety instructions

WARNING! Obey these instructions. If you ignore them, injury or death, or damage to the equipment can occur. If you are not a qualified electrical professional, do not do electrical installation or maintenance work.

- Do not do work on the drive, motor cable, motor, or control cables when the drive is connected to the input power. Before you start the work, isolate the drive from all dangerous voltage sources and make sure that it is safe to start the work. Always wait for 5 minutes after disconnecting the input power to let the intermediate circuit capacitors discharge.
- Do not do work on the drive when a rotating permanent magnet motor is connected to it. A rotating permanent magnet motor energizes the drive, including its input and output terminals.

1. Unpack the delivery

Keep the drive in its package until you are ready to install it. After unpacking, protect the drive from dust, debris and moisture.

Make sure that these items are included:

- drive
- assistant control panel
- options, if ordered
- RIIO-01 I/O & EIA-485 module. **Note:** If a fieldbus adapter is ordered, it replaces the RIIO-01 module of the standard delivery.
- mounting template (frames R3 and R4 only)
- installation accessories (cable clamps, etc.)
- multilingual warning sticker sheet (residual voltage warning)
- safety instructions
- quick installation and start-up guide
- hardware and firmware manuals, if ordered.

Make sure that there are no signs of damage to the items.

2. Reform the capacitors

If the drive has not been powered up for a year or more, you must reform the DC link capacitors. The manufacturing date is on the type designation label. Refer to [Capacitor reforming instructions \(3BFE64059629 \[English\]\)](#).

3. Select the cables and fuses

- Select the power cables. Obey the local regulations.
 - Input power cable:** ABB recommends to use symmetrical shielded cable (VFD cable) for the best EMC performance.
 - Motor cable:** Use symmetrical shielded cable (VFD cable) for the best EMC performance. Symmetrical shielded cable also reduces bearing currents, wear, and stress on motor insulation.
 - Power cable types:** In IEC installations, use copper or aluminum cables (if permitted). In UL installations, use only copper cables.
 - Current rating:** max. load current.
 - Voltage rating:** min. 600 V AC.
 - Temperature rating:** In IEC installations, select a cable rated for at least 70 °C (158 °F) maximum permissible temperature of conductor in continuous use. In UL installations, select a cable rated for at least 75 °C (167 °F).
 - Size:** Refer to [Fuses and typical power cable sizes](#) for the typical cable sizes and to [Terminal data for the power cables](#) for the maximum cable sizes.
- Select the control cables. Use double-shielded twisted-pair cable for analog signals. Use double-shielded or single-shielded cable for the digital, relay and I/O signals. Do not run 24 V and 115/230 V signals in the same cable.
- Protect the drive and input power cable with the correct fuses. Refer to [Fuses and typical power cable sizes](#).

4. Examine the installation area

The drive is intended for cabinet installation and has a degree of protection of IP20 / UL open type.

Examine the site where you will install the drive. Make sure that:

- The installation site is sufficiently ventilated and hot air does not recirculate.
- There is sufficient free space around the drive for cooling, maintenance, and operation. For the minimum free space requirements, refer to [Free space requirements](#).
- The ambient conditions meet the requirements. Refer to [Ambient conditions](#).
- The installation surface is as close to vertical as possible and strong enough to support the weight of the drive. Refer to [Dimensions and weights](#).
- The installation surface, floor and materials near the drive are not flammable.
- There are no sources of strong magnetic fields, such as high-current single-core conductors or contactor coils near the drive. A strong magnetic field can cause interference in the operation of the drive.

5. Install the drive

You can install the drive with screws, or to a DIN rail (top hat type, width x height = 35 mm x 7.5 mm [1.4 in x 0.3 in]).

- Install R0 drives vertically. R0 drives do not have a cooling fan.
- You can install drives with frame size R1...R4 tilted by a maximum of 90 degrees, from vertical to fully horizontal orientation.
- Do not install the drive upside down.
- You can install several drives side by side.

To install the drive with screws

- Make marks onto the surface for the mounting holes. Refer to [Dimensions and weights](#). Use the included mounting template for frames R3 and R4.
- Drill the holes for the mounting screws. If necessary, install suitable plugs or anchors into the holes.
- Install the mounting screws into the holes. Leave a gap between the screw head and installation surface.
- Put the drive onto the mounting screws.
- Tighten the mounting screws.

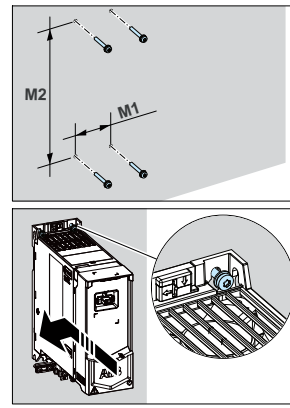

To install the drive to a DIN rail

- Move the locking part to the left. If necessary, use a flat-head screwdriver.
- Push and hold the locking button down.
- Put the top tabs of the drive onto the top edge of the DIN rail.
- Put the drive against the bottom edge of the DIN rail.
- Release the locking button.
- Move the locking part to the right.
- Make sure that the drive is correctly installed.

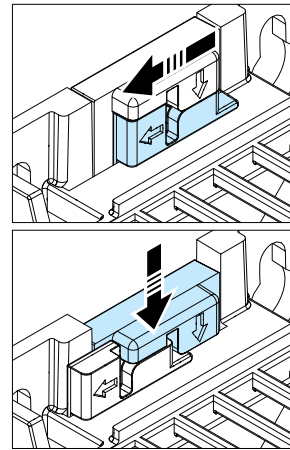

To remove the drive, open the locking part and lift the drive from the DIN rail.

6. Measure the insulation resistance

Drive: Do not do voltage tolerance or insulation resistance tests on the drive, because this can cause damage to the drive.

Input power cable: Before you connect the input power cable, measure the insulation of the input power cable. Obey the local regulations.

Motor and motor cable:

- Make sure that the motor cable is connected to the motor and disconnected from the drive output terminals T1/U, T2/V and T3/W.
- Use a voltage of 1000 V DC to measure the insulation resistance between each phase conductor and the protective earth conductor. The insulation resistance of an ABB motor must be more than 100 Mohm (at 25 °C [77 °F]). For the insulation resistance of other motors, refer to the manufacturer's documentation. Moisture in the motor decreases the insulation resistance. If you think that there is moisture in the motor, dry the motor and do the measurement again.

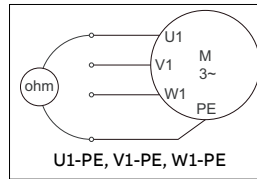

7. Make sure that the drive is compatible with the grounding system

You can connect all drive types to a symmetrically grounded TN-S system (center-grounded wye). The drive is delivered with the EMC and VAR screws installed. The material of the screws (plastic or metal) depends on the product variant. The table shows when to remove the metal EMC screw (disconnect the internal EMC filter) or metal VAR screw (disconnect the varistor circuit).

Screw label	Factory default screw material	Grounding systems		
		Symmetrically grounded TN-S systems (center-grounded wye)	Corner-grounded delta, midpoint-grounded delta and TT systems	IT systems (ungrounded or high-resistance grounded)
EMC	Metal	Do not remove	Remove	Remove
	Plastic ¹⁾	Do not remove ²⁾	Do not remove	Do not remove
VAR	Metal	Do not remove	Do not remove	Remove
	Plastic	Do not remove	Do not remove	Do not remove

- UL (NEC) types have a plastic EMC screw.
- Can install the metal screw (included in the drive delivery) to connect the internal EMC filter.

8. Connect the power cables

Connection diagram (shielded cables)

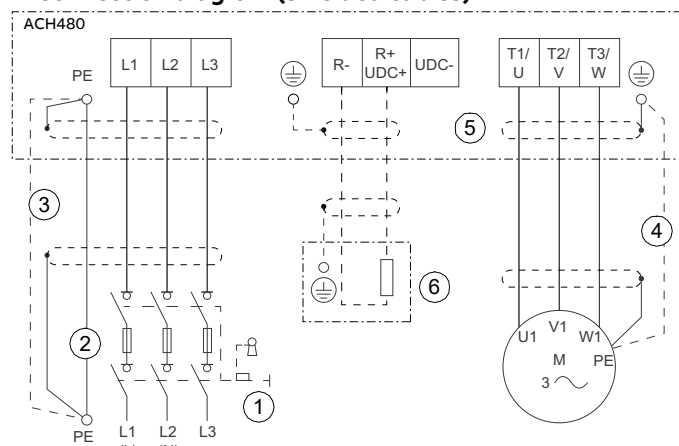

- Disconnecting device.
- Two protective earth (ground) conductors. Drive safety standard IEC/EN 61800-5-1 requires two PE conductors, if the cross-sectional area of the PE conductor is less than 10 mm² Cu or 16 mm² Al. For example, you can use the cable shield in addition to the fourth conductor.
- Use a separate grounding cable or a cable with a separate PE conductor for the line side, if the conductivity of the fourth conductor or shield does not meet the requirements for the PE conductor.
- Use a separate grounding cable for the motor side, if the conductivity of the shield is not sufficient, or if there is no symmetrically constructed PE conductor in the cable.
- 360-degree grounding of the cable shield is required for the motor cable and brake resistor cable (if used). It is also recommended for the input power cable.
- Brake resistor and resistor cable (optional).

Connection procedure (shielded cables)

For the tightening torques, refer to [Terminal data for the power cables](#).

- Loosen the screw on the front cover. Then lift the front cover up.
- Attach the residual voltage warning sticker in the local language to the drive.
- Strip the motor cable.
- Ground the motor cable shield under the grounding clamp.
- Twist the motor cable shield into a bundle, mark it and connect it to the grounding terminal.

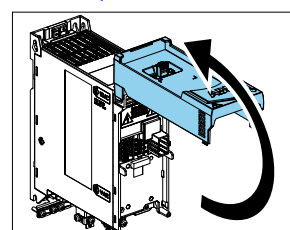

- Connect the phase conductors of the motor cable to terminals T1/U, T2/V and T3/W.
- If used, connect the brake resistor cable to terminals R- and UDC+. Use a shielded cable and ground the shield under the grounding clamp.
- Make sure that the R- and UDC+ terminal screws are tightened. Do this step also if you do not connect cables to the terminals.
- Strip the input power cable.
- If the input power cable has a shield, ground the shield under the grounding clamp. Then twist the shield into a bundle, mark it and connect it to the grounding terminal.
- Connect the PE conductor of the input power cable to the grounding terminal. If necessary, use a second PE conductor.
- In 3-phase drives, connect the phase conductors of the input power cable to terminals L1, L2 and L3. In 1-phase drives, connect the phase and neutral conductors to terminals L1 and L2.
- Mechanically attach the cables on the outside of the drive.

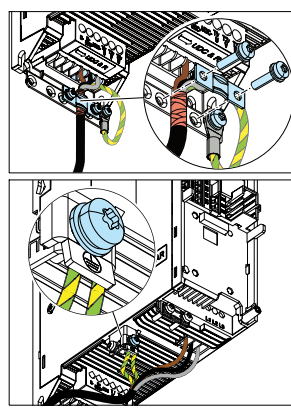

9. Install the communication module

To install the communication module (I/O module or fieldbus module):

- Pull out the locking tab of the communication module.
- Align the communication module contacts with the contacts on the drive. Carefully push the module into position.
- Push in the locking tab of the communication module.
- Tighten the locking screw to fully attach and electrically ground the communication module.

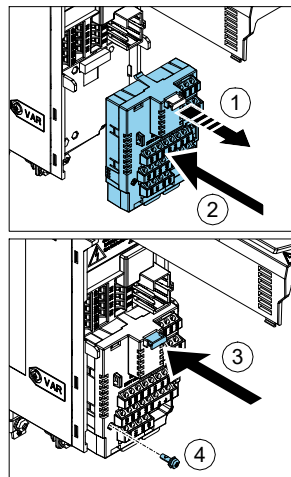

10. Connect the control cables

Keep the signal wire pairs twisted as near to the terminals as possible to prevent inductive coupling. The tightening torque for the terminal connections is 0.5 ... 0.6 N·m (4.4 ... 5.3 lbf·in).

- Strip a part of the outer shield of the control cable for grounding.
- Use a cable tie to ground the outer shield to the grounding tab.
- Strip the control cable conductors.
- Connect the conductors to the correct control terminals.
- Connect the shields of the twisted pairs and grounding wires to the SCR terminal.
- Mechanically attach the control cables on the outside of the drive.

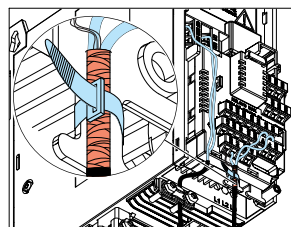

Default I/O connections (HVAC default)

Terminal	Description	1)
Reference voltage and analog I/O		
1 ... 10 kohm	1 SCR Signal cable shield (screen)	
	2 AI1 Output freq./speed reference: 0 ... 10 V	
	3 AGND Analog input circuit common	
	4 +10 V Reference voltage 10 V DC	
	5 AI2 Actual feedback: 0 ... 20 mA	
	6 AGND Analog input circuit common	
	7 AO1 Output frequency: 0 ... 20 mA	
	8 AO2 Output current: 0 ... 20 mA	
	9 AGND Analog output circuit common	
Aux. voltage output and programmable digital inputs		
	10 +24 V Aux. voltage output +24 V DC, max. 250 mA	x
	11 DGND Aux. voltage output common	x
	12 DCOM Digital input common for all	x
	13 DI1 Stop (0)/Start (1)	x
	14 DI2 Not configured	x
	15 DI3 Constant frequency/speed selection	
	16 DI4 Start interlock 1 (1 = allow start)	
	17 DI5 Not configured	
	18 DI6 Not configured	
Relay outputs		
	19 RO1C Damper control	x
	20 RO1A 250V AC / 30 V DC	x
	21 RO1B 2 A	x
	22 RO2C Running	
	23 RO2A 250V AC / 30 V DC	
	24 RO2B 2 A	
	25 RO3C Fault (-1)	
	26 RO3A 250V AC / 30 V DC	
	27 RO3B 2 A	
Safe torque off		
	34 SGND Safe torque off (STO). Both circuits must be closed for the drive to start. The drawing shows the simplified connection of a safety circuit through safety contacts. If STO is not used, leave the factory-installed jumpers in place. See also section Safe torque off (STO) .	x
	35 IN1	x
	36 IN2	x
	37 OUT1	x

1) x = on base unit, empty = on RIIO-01 I/O extension module

Embedded fieldbus connection

You can connect the drive to an EIA-485 serial communication link through the embedded fieldbus interface on the RIIO-01 module. The embedded fieldbus interface supports the BACnet MS/TP, Modbus RTU, and N2 protocols.

To configure EIA-485 communication with the embedded fieldbus:

- Connect the fieldbus cables and the necessary I/O signals.
- Use the termination switch to set the correct termination.
- Power up the drive and set the necessary parameters.

A connection example is shown below.

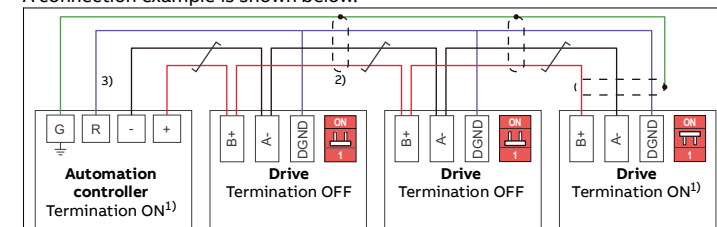

- The devices at the ends of the fieldbus must have termination set to ON. All other devices must have termination set to OFF (1).
- Attach the cable shields together at each drive, but do not connect them to the drive. Connect the shields only to the grounding terminal in the automation controller.
- Connect the signal ground (DGND) conductor to the signal ground reference terminal in the automation controller. If the automation controller does not have a signal ground reference terminal, you can connect the signal ground to the cable shields through a 100 ohm resistor, preferably near the controller.

11. Install the control panel

To install the control panel:

- Close the front cover and tighten the screw.
- Put the bottom edge of the control panel into position.
- Push the top of the control panel until it locks into position.

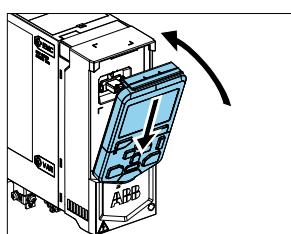

12. Start up the drive

WARNING! Before you start up the drive, make sure that the installation is completed. Make sure also that it is safe to start the motor. Disconnect the motor from other machinery, if there is a risk of damage or injury.

The control panel has softkeys below the display to access the related commands, and arrow keys to navigate the menu and change parameter values. Push the "?" button to open the help function.

Make sure that you have the motor nameplate data available.

- Power up the drive. The first start assistant runs automatically. Wait until the control panel shows the language selection list.



- Select *Commission the drive* and push the right softkey (Next).

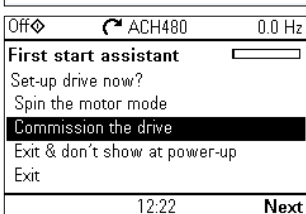

- Select the localization and push the right softkey (Next).

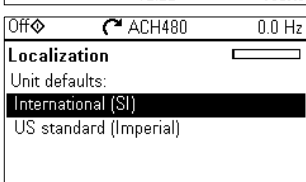

- To complete the first start assistant, enter the settings and values when you are prompted.

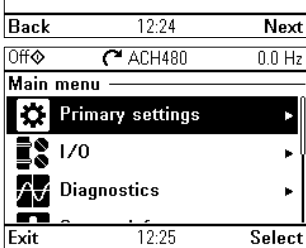

You can also use **Primary settings** in the Main menu to configure the unit.

In **Primary settings** you can, for example, set operation limits (speed), and acceleration and deceleration ramps as required by the application.

In **I/O**, you can define external control signal sources (IO or fieldbus).

WARNING! If you activate the automatic fault reset or automatic restart functions of the drive control program, make sure that no dangerous situations can occur. These functions reset the drive automatically and continue operation after a fault or supply break. If these functions are activated, the installation must be clearly marked as defined in IEC/EN 61800-5-1, subclause 6.5.3, for example, "THIS MACHINE STARTS AUTOMATICALLY".

Fieldbus settings

If necessary, configure the drive for fieldbus communication. The table below shows the minimum set of parameters required to configure BACnet MS/TP communication through the embedded fieldbus interface. If you use a fieldbus adapter, refer to the applicable fieldbus adapter documentation.

No.	Name	Value
20.01	Ext1 commands	Embedded fieldbus
22.11	Ext1 speed ref1 (vector)	EFB ref1
28.11	Ext1 frequency ref1 (scalar)	EFB ref1
31.11	Fault reset selection	D11 ¹⁾
58.01	Protocol enable	BACnet MSTP
58.03	Node address	1 (default)
58.04	Baud rate	Autodetect (default)
58.40	Device object ID	User-defined (range 0...4194302)

1) If you select D11, you must connect the reset signal to digital input D11.

Warnings and faults

Warning	Fault	Description
A2A1	2281	Warning: Current calibration is done at the next start. Fault: Output phase current measurement fault.
A2B1	2310	Overcurrent. The output current is more than the internal limit. This can be caused by an earth fault or phase loss.
A2B3	2330	Earth leakage. A load unbalance that is typically caused by an earth fault in the motor or the motor cable.
A2B4	2340	Short circuit. There is a short circuit in the motor or the motor cable.
-	3130	Input phase loss. The intermediate DC circuit voltage oscillates.
-	3181	Cross connection. The input and motor cable connections are incorrect.
A3A1	3210	DC link overvoltage. There is an overvoltage in the intermediate DC circuit.
A3A2	3220	DC link undervoltage. There is an undervoltage in the intermediate DC circuit.
-	3381	Output phase loss. All three phases are not connected to the motor.
A5A0	5091	Safe torque off. The Safe torque off (STO) function is on.
-	6681	EFB communication loss. There is a problem with the embedded fieldbus connection.
-	7510	FBA A communication. Communication is lost between drive and fieldbus adapter, or between controller and fieldbus adapter.
A7AB	-	Extension I/O configuration failure. The installed extension module is not the same as configured.
AFF6	-	Identification run. The motor ID run occurs at the next start.
-	FA81	Safe torque off 1. The Safe torque off circuit 1 is broken.
-	FA82	Safe torque off 2. The Safe torque off circuit 2 is broken.

Ratings

IEC type ACH480-04-...	Input ratings		Output ratings				Frame size
	No choke	With choke	Max. current	Nominal use	Light-duty use		
	I_{N1}	I_{N2}	I_{max}	I_N	P_N	I_{Ld}	P_{Ld}
	A	A	A	A	kW	A	kW
1-phase $U_N = 230 V^{1)}$							
02A4-1	5.0	4.2	3.2	2.4	0.37	2.3	2.4
03A7-1	7.1	6.4	4.3	3.7	0.55	3.5	3.7

Related documents

ACH480 hardware manual

ACH480 manual list

Ecodesign information (EU 2019/1781)



3AXD50000247141 Rev C EN 2021-07-20
Original instructions.
© Copyright 2021 ABB. All rights reserved.



3AXD50000247141C

IEC type ACH480-04-...	Input ratings		Output ratings				Frame size
	No choke	With choke	Max. current	Nominal use		Light-duty use	
	I_{N1}	I_{N2}	I_{max}	I_N	P_N	I_{Ld}	P_{Ld}
	A	A	A	A	kW	A	kW
04A8-1	8.8	8.3	6.7	4.8	0.75	4.6	0.75
06A9-1	12.0	11.9	8.6	6.9	1.10	6.6	1.10
07A8-1	14.2	13.5	12.4	7.8	1.5	7.4	1.5
09A8-1	18.7	17.0	14.0	9.8	2.2	9.3	2.2
12A2-1	24.6	21.1	17.6	12.2	3.0	11.6	3.0
3-phase $U_N = 230 V^{1)}$							
02A4-2	3.6	2.4	3.2	2.4	0.37	2.4	0.37
03A7-2	5.1	3.7	4.3	3.7	0.55	3.2	0.55
04A8-2	6.3	4.8	6.7	4.8	0.75	4.6	0.75
06A9-2	8.4	6.9	8.6	6.9	1.1	6.6	1.1
07A8-2	10.1	7.8	12.4	7.8	1.5	7.5	1.5
09A8-2	13.8	9.8	14.0	9.8	2.2	9.3	2.2
12A2-2	17.3	12.2	17.6	12.2	3.0	11.6	3.0
17A5-2	22.2	17.5	22.0	17.5	4.0	16.7	4.0
25A0-2	29.1	25.0	31.5	25.0	5.5	24.2	5.5
032A-2	37.0	32.0	45.0	32.0	7.5	30.8	7.5
048A-2	50.0	48.0	57.6	48.0	11.0	46.2	11.0
055A-2	60.0	55.0	86.4	55.0	15.0	52.8	15.0
3-phase $U_N = 400 V$							
02A7-4	3.8	2.6	3.2	2.6	0.75	2.5	0.75
03A4-4	5.1	3.3	4.7	3.3	1.1	3.1	1.1
04A1-4	6.4	4.0	5.9	4.0	1.5	3.8	1.5
05A7-4	8.9	5.6	7.2	5.6	2.2	5.3	2.2
07A3-4	10.9	7.2	10.1	7.2	3.0	6.8	3.0
09A5-4	13.9	9.4	13.0	9.4	4.0	8.9	4.0
12A7-4	17.6	12.6	16.9	12.6	5.5	12.0	5.5
018A-4	25.2	17.0	22.7	17.0	7.5	16.2	7.5
026A-4	34.1	25.0	30.6	25.0	11.0	23.8	11.0
033A-4	43.4	32.0	45.0	32.0	15.0	30.5	15.0
039A-4	52.3	38.0	57.6	38.0	18.5	36.0	18.5
046A-4	56.0	45.0	68.4	45.0	22.0	42.8	22.0
050A-4	58.9	50.0	81.0	50.0	22.0	48.0	22.0

UL (NEC) type ACH480-04-...	Input ratings		Output ratings				Frame size
	No choke	With choke	Max. current	Light-duty use			
	I_{Ld}	I_{Ld}	I_{max}	I_{Ld}	P_{Ld}		
	A	A	A	A	hp		
1-phase $U_N = 230 V^{1)}$							
02A3-1	4.8	4.0	3.2	2.3	0.5	R0	
03A5-1	6.8	6.1	4.3	3.5	0.8	R0	
04A6-1	8.2	8.0	6.7	4.6	1.0	R1	
06A6-1	12.0	11.4	8.6	6.6	1.5	R1	
07A4-1	13.0	12.8	12.4	7.4	2.0	R1	
09A3-1	18.0	16.1	14.0	9.3	3.0	R2	
11A6-1	20.6	20.1	17.6	11.6	3.0	R2	
3-phase $U_N = 230 V^{1)}$							
02A3-2	3.5	2.4	3.2	2.4	0.5	R1	
03A5-2	4.8	3.2	4.3	3.2	0.75	R1	
04A6-2	5.8	4.6	6.7	4.6	1.0	R1	
06A6-2	8.3	6.6	8.6	6.6	1.5	R1	
07A5-2	9.2	7.5	12.4	7.5	2.0	R1	
11A6-2	12.8	11.6	17.6	11.6	3.0	R2	
017A-2	20.5	16.7	22.0	16.7	5.0	R3	
024A-2	29.7	24.2	31.5	24.2	7.5	R3	
031A-2	36.0	30.8	45.0	30.8	10.0	R4	
046A-2	50.5	46.2	57.6	46.2	15.0	R4	
053A-2	57.6	52.8	86.4	52.8	20.0	R4	
3-phase $U_N = 480 V$							
02A1-4	3.0	2.1	3.2	2.1	1.0	R1	
03A0-4	4.3	3.0	4.7	3.0	1.5	R1	
03A5-4	4.9	3.5	5.9	3.5	2.0	R1	
04A8-4	6.7	4.8	7.2	4.8	3.0	R1	
06A0-4	6.7	6.0	10.1	6.0	3.0	R1	
07A6-4	10.6	7.6	13.0	7.6	5.0	R1	
011A-4	14.9	11.0	16.9	11.0	7.5	R2	
014A-4	20.2	14.0	22.7	14.0	10.0	R3	
021A-4	28.5	21.0	30.6	21.0	15.0	R3	
027A-4	35.8	27.0	45.0	27.0	20.0	R4	
034A-4	43.8	34.0	57.6	34.0	25.0	R4	
042A-4	49.4	42.0	81.0	42.0	30.0	R4	

1) 230 V drives not available at the time of publication. For availability, contact ABB.

Fuses and typical power cable sizes

IEC type ACH480-04-...	UL (NEC) type ACH480-04-...	Fuses			Cable conductor sizes (Cu)		Frame size
		gG	gR	UL class (1) 2) 3)	mm ²	AWG	
		ABB type	Bussmann type	Bussmann/Edison type			
1-phase $U_N = 230 V$							
02A4-1	02A3-1	OFAF000H10	170M2695	JJN/TJN10	3x1.5 + 1.5	16	R0
03A7-1	03A5-1	OFAF000H10	170M2695	JJN/TJN10	3x1.5 + 1.5	16	R0
04A8-1	04A6-1	OFAF000H16	170M2696	JJN/TJN20	3x1.5 + 1.5	16	R1
06A9-1	06A6-1	OFAF000H20	170M2697	JJN/TJN20	3x1.5 + 1.5	16	R1
07A8-1	07A4-1	OFAF000H25	170M2698	JJN/TJN25	3x1.5 + 1.5	16	R1
09A8-1	09A3-1	OFAF000H32	170M2698	JJN/TJN25	3x2.5 + 2.5	14	R2
12A2-1	11A6-1	OFAF000H35	170M2698	JJN/TJN35	3x2.5 + 2.5	14	R2
3-phase $U_N = 230 V$							
02A4-2	02A3-2	OFAF000H6	170M2694	JJS/TJS6	3x1.5 + 1.5	16	R1
03A7-2	03A5-2	OFAF000H10	170M2695	JJS/TJS10	3x1.5 + 1.5	16	R1
04A8-2	04A6-2	OFAF000H10	170M2695	JJS/TJS10	3x1.5 + 1.5	16	R1
06A9-2	06A6-2	OFAF000H16	170M2696	JJS/TJS20	3x1.5 + 1.5	16	R1
07A8-2	07A5-2	OFAF000H16	170M2696	JJS/TJS20	3x1.5 + 1.5	16	R1
09A8-2	-	OFAF000H16	170M2696	JJS/TJS20	3x2.5 + 2.5	14	R1
12A2-2	11A6-2	OFAF000H25	170M2697	JJS/TJS25	3x2.5 + 2.5	14	R2
17A5-2	017A-2	OFAF000H32	170M2698	JJS/TJS35	3x6 + 6	10	R3
25A0-2	024A-2	OFAF000H50	170M2699	JJS/TJS50	3x6 + 6	10	R3
032A-2	031A-2	OFAF000H63	170M2700	JJS/TJS60	3x10 + 10	8	R3
048A-2	046A-2	OFAF000H100	170M2702	JJS/TJS100	3x25 + 16	4	R4
055A-2	053A-2	OFAF000H100	170M2702	JJS/TJS100	3x25 + 16	4	R4
3-phase $U_N = 400 V$ or 480 V							
02A7-4	02A1-4	OFAF000H6	170M2694	JJS/TJS6	3x1.5 + 1.5	16	R1
03A4-4	03A0-4	OFAF000H6	170M2694	JJS/TJS6	3x1.5 + 1.5	16	R1
04A1-4	03A5-4	OFAF000H10	170M2695	JJS/TJS10	3x1.5 + 1.5	16	R1
05A7-4	04A8-4	OFAF000H10	170M2695	JJS/TJS10	3x1.5 + 1.5	16	R1
07A3-4	06A0-4	OFAF000H16	170M2696	JJS/TJS20	3x1.5 + 1.5	16	R1
09A5-4	07A6-4	OFAF000H16	170M2696	JJS/TJS20	3x2.5 + 2.5	14	R1
12A7-4	011A-4						